



A Guide to Quick Installation

Three-phase Grid-tied PV String Inverter:

6K/8K/10K

12K/15K

Quality Guarantee

Where otherwise agreed to in a contract, quality warranty period of the inverter is 60 months. The PV inverter defective or damaged within its quality warranty period shall be repaired or replaced for free. However, warranty or liability will be void if damage is caused from below operations/situations:

1. The warranty period expired;
2. The damage caused during transit;
3. The damage caused by force majeure including, but not restricted to the following: earthquake, flood, fire, explosion, debris flow etc;
4. Operation in adverse environments beyond that described in User Manual;
5. Any installation and operation environment beyond the relevant national standards;
6. Any installing, reconfiguring, or using faulty;
7. Any revising the product or modifying its software code without authorization;
8. Maintenance faulty caused by the technician personnel unauthorized;
9. Any operation ignoring the safety precautions stipulated in User Manual;

Symbol Conventions

Read through the safety symbols used in this manual, which highlight potential safety risks and important safety information, before using the inverter.

Symbol	Description
	DANGER Indicates an imminently hazardous situation which, if not correctly followed, will result in serious injury or death.
	WARNING Indicates a potentially hazardous situation which, if not correctly followed, could result in serious injury or death.
	CAUTION Indicates a potentially hazardous situation which, if not correctly followed, could result in moderate or minor injury.
	NOTICE Indicates a potentially hazardous situation which, if not correctly followed, could result in equipment failure to run, or property damage.
	NOTE Calls attention to important information, best practices and tips: supplement additional safety instructions for your better use of the PV inverter to reduce the waste of your resource.

Outline and Dimensions

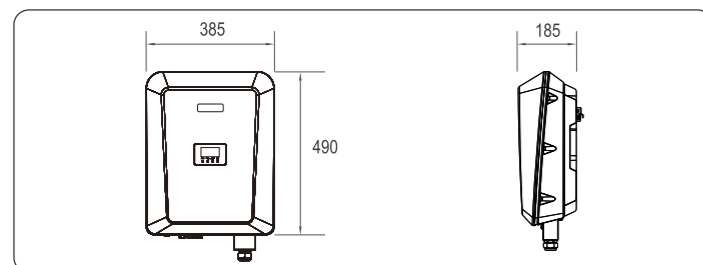

Installation

The deliverables in the fittings of inverter

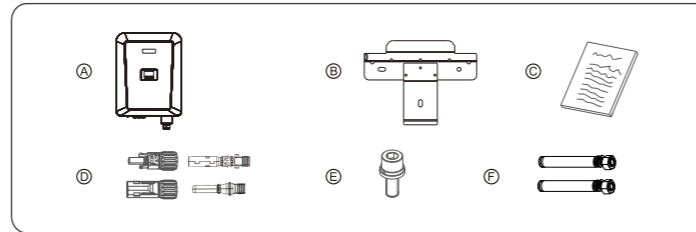

Items	Deliverables
A	The inverter
B	Rear panel
C	File package
D	DC terminal connector group
E	screw
F	Expansion screw (reserved for tightening the support and rear panel)

Determining the Installation Position

The inverter must be installed on the place where is free from direct exposure to sunlight, rain, and snow to extend its service life.

Installation Space Requirements

Reserve enough clearance around the inverter to ensure sufficient space for installation and heat dissipation, as shown in below Figure. When installing multiple inverters, ensure 200mm distance between inverters' lateral sides, 500mm-600mm between inverters' top and/or bottom sides, and 1000mm clearance between inverters' front sides.

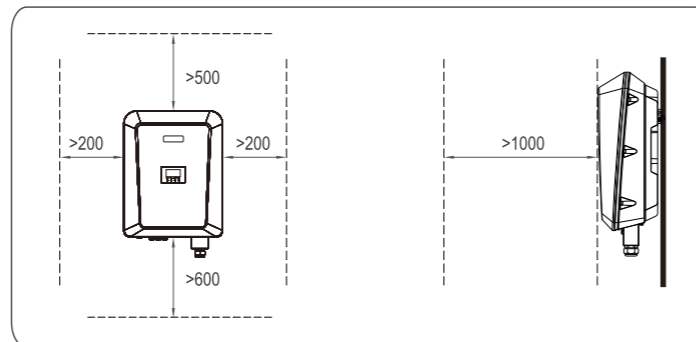

Inverter fixation

Step 1 Drill a hole in the marked position using a hammer drill, and insert expansion screw through rear panel hole and knock the screw completely into the hole, and secure the rear panel.

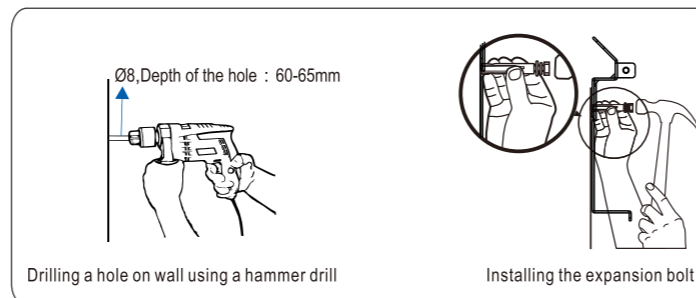

Step2 Tighten the expansion screw and finish the installation of the rear panel.

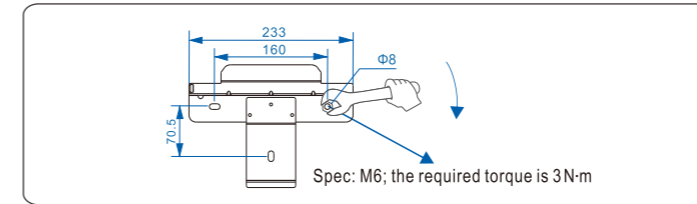

Step3 Mount the inverter on the rear panel and keep them aligned with each other.

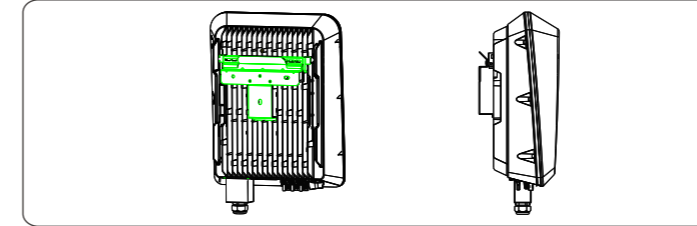

Step4 Tighten the two hexagon screws at the bottom of the inverter and the retaining screws on the rear panel, and ensure that they are secured.

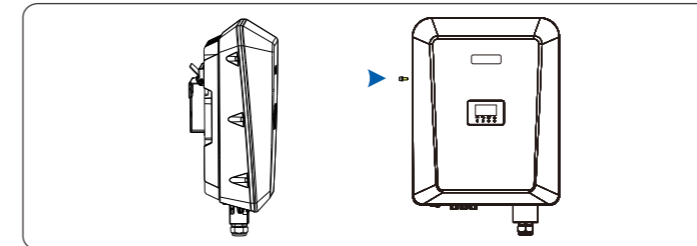

Installation Self-check

1. Ensure that the supporting points (on the rear side of the inverter) align with the holes of the support.
2. Ensure that the inverter is well fixed.
3. Ensure that the inverter is locked on the support.

Preparation before wiring

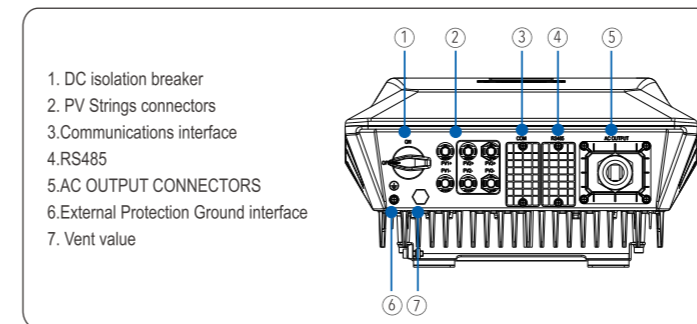

Electrical Connections

	DANGER Before performing any electrical connections, ensure that both DC and AC Switches are OFF. Otherwise, fatal injury can occur due to the high voltage caused from AC and DC cables.
	CAUTION Grounding the PV Strings needs below prerequisites. An isolation transformer must be installed on the AC side of each inverter; Ensure that the neutral wire of the isolation transformer must be disconnected from the PGND cable. One isolation transformer is with one PV inverter: do not install a single isolation transformer for multiple inverters; otherwise, circulating current generated by the inverters will lead to operation failure. Select "Isolation SET" on the APP, and set in "Input Grounded", "With TF".

Cable specifications (recommended)

Cable	Cable type	Cross-sectional Area (mm ²)		Cable Outer Diameter (mm)
		Range	Recommended Value	Range
AC cable	multi-core outdoor cable	4~6	4	11~18
DC cable	common PV cables in the industry (model: PV1-F)	2.5~4	4	4~5
External PGND cable	multi-core outdoor cable	4~6	6	NA

Connecting External PGND Cables

Step 1 Remove an appropriate length of the insulation layer from the external PGND cable using a wire stripper.

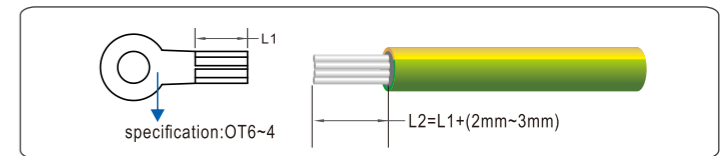

Step 2 Insert the exposed core wires into the crimp area of the OT terminal and crimp them using hydraulic pliers, and crimp them with hydraulic crimping pliers.

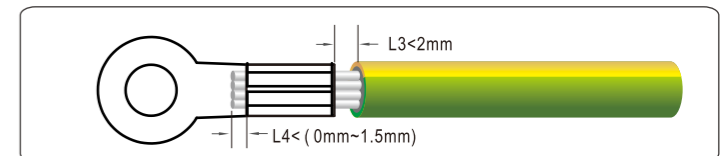

Step 3 Secure the PGND cable using the ground screw and tighten the screw to a torque of 1.2 N·m.

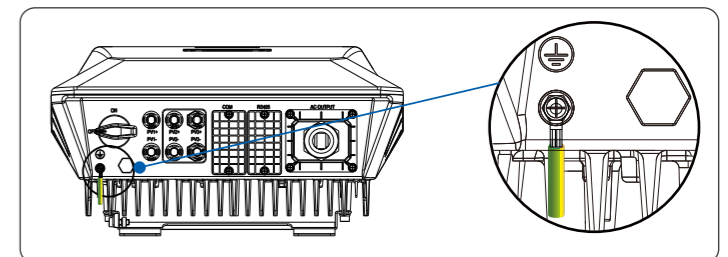

Connecting AC Output Cables

	NOTICE For your operation and safety sake, please prepare multi-stranded wire, crimping terminals and a proper crimping tool before AC Wiring.
--	---

Step 1 Remove an appropriate length of the jacket and insulation layer from the AC output cable.

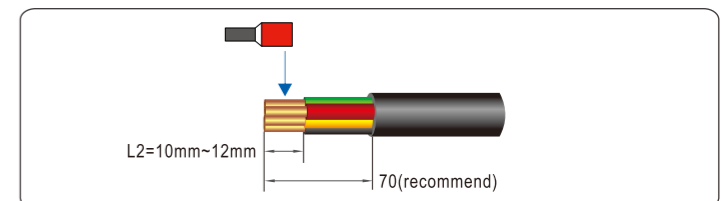

Step 2 Insert the exposed core wires into the crimp area of the Europe type terminal and crimp them using specific tools and effect of the crimped.

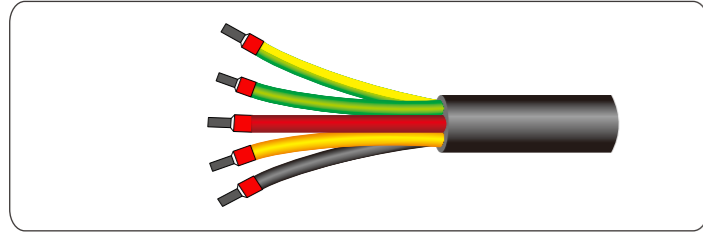

Step 3 Insert the processed AC output cables through waterproof terminals with reserved wire length for electrical connecting.

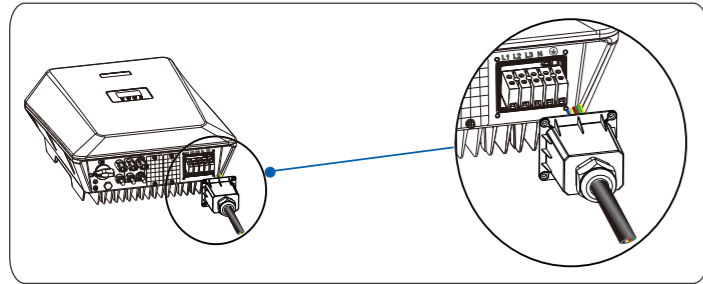

Step 4 Rout AC output cables to L1, L2, L3, N, and E on the AC terminal block respectively, and tighten them using screw driver to a torque of 1.5N.m.

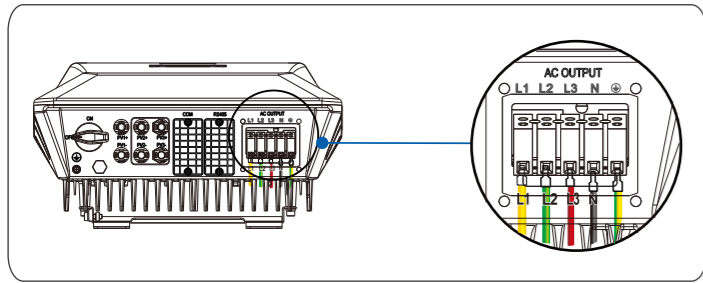

Step 5 Aligning with the hole position on the AC terminal cover, use a screw driver to tighten screws to a torque of 1.2 N.m.

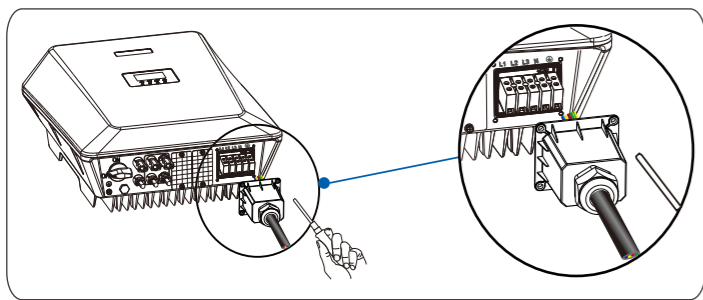

Step 6 Use a torque wrench to tighten the locking cap on the AC cable to a torque of 5 N.m.

Connecting the PV Strings

- Step 1 Remove an appropriate length of the insulation layer from the positive and negative power cables using a wire stripper, as shown in below Figure.
- Step 2 Insert the exposed areas of the positive and negative power cables into the metal terminals of the positive and negative connectors respectively, crimp them, and tighten the locking nuts on the positive and negative connectors using a removal wrench.
- Step 3 Take out the protective plug from the DC terminals of the inverter, insert the positive and negative connectors into the corresponding connector terminals of the inverter until a "click" sound is heard.

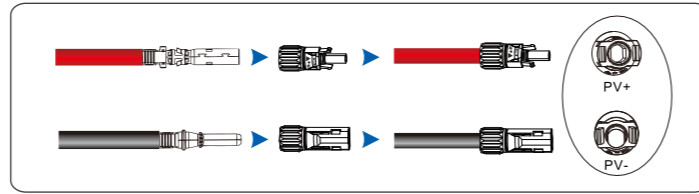

WARNING When taking out DC connectors, please ensure that PV Strings are disconnected; otherwise, a fire can occur.

Inverter Uninstall

Inverter uninstall requires below procedure:

- Step 1 Disconnect all electric connections including these of communications cables, DC input cables, AC output cables and the PGND cables.

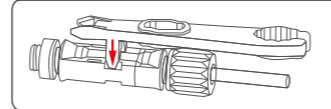

When uninstalling DC input connectors, insert removal wrench into the bayonet shown in Figure, press the wrench down, and take out the connector.

- Step 2 Remove the inverter from its rear panel.
- Step 3 Remove the rear panel.

WARNING Before uninstalling DC input connector, please ensure that the DC SWITCH is set to OFF to avert equipment damage and/or personal injury.

Installing RS485 communications cable procedure

- Step 1 Remove an appropriate length of the insulation layer from cable using a wire stripper.

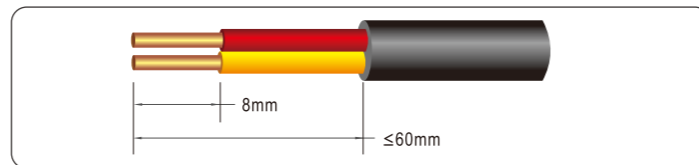

- Step 2 Remove the RS485 screws at the inverter bottom to remove the metal plate.

- Step 3 Take RS485 cable out of accessory kit, and remove the locking caps from the 485 IN and 485 OUT waterproof cable connectors. Route RS485 cables through waterproof cable connectors and reserve appreciate wire length for wiring to the inverter.

- Step 4 Connect RS485 differential positive and negative signal of data logger to terminal 1A and 1B of inverter, and connect terminal 2A and 2B of the inverter to terminal 1A and 1B of another inverter.

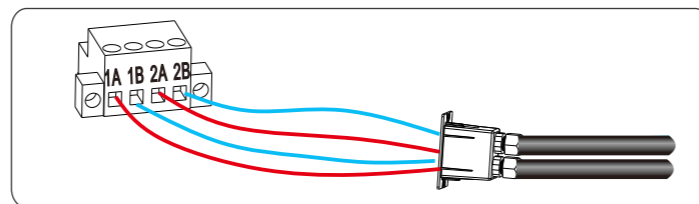

- Step 5 Connect RS485 male terminal with its female terminal, Tighten the locking caps to a torque of 8 N-m as well as waterproof cable connectors.

System Operation

Switch ON the AC circuit breaker and set the DC SWITCH of the inverter to ON. Observe statuses of grid-connecting light on the inverter for a while, and if the lights display that the inverter has entered gridconnecting, it means the inverter is operating well. Any query during operating the PV inverter, call your dealer.

To power OFF the Inverter, switch off the circuit breaker at AC terminal, and set the DC SWITCH to OFF.

WARNING After the inverter power is off, the remaining electricity and heat may still cause electrical shock and body burns. Please only begin servicing the inverter 10 minutes after the power-off.

Interface

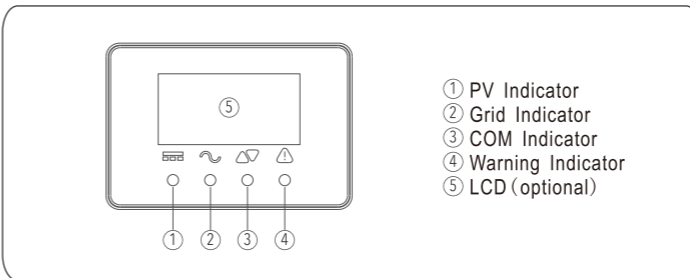

LED Indicator

LED Indicator	status	descriptions
PV Indicator	on	Voltage of PV strings meets the requirements for inverter grid-connecting to generate power.
	blink	Voltage of PV strings can't meet the requirements for inverter grid-connecting to generate power.
Grid Indicator	blink	Power grid abnormal, and can't meet the requirements for inverter grid-connecting to generate power.
	on	When grid-on, the blink (every cycle last 30s) of Grid Indicator means loading amounts: quantity of blink means power size, and after that the Indicator keeps ON. When less than 20% rated power, blink one time; 20%~40% rated power, blink twice every 30s; 40%~60% rated power, blink three times every 30s; 60%~80% rated power, blink four times every 30s; 80%~100% rated power, blink five times every 30s.
COM Indicator	blink	Communications data transmission is underway.
	off	No external communications is connected or no communications data transmission.
Warning Indicator	on/blink	Refer LED status in warning table.
	off	No warning.

LCD Screen

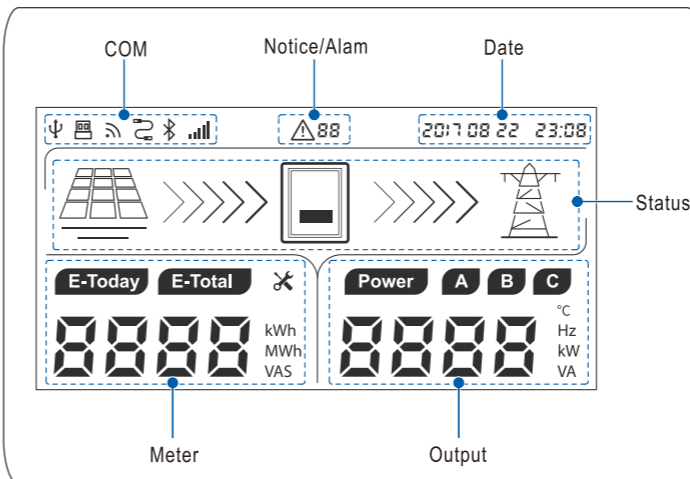

LED status and Warning code

	Warning code	PV indicator	Grid indicator	COM indicator	Warning indicator
Normal status		●	●/★	◎	○
Starting up		●	○	◎	○
WLAN/WIFI/RS485 communication		◎	◎	★	○
PV normal		●*	◎	◎	○
Grid over voltage	A0				
Grid under voltage	A1				
Grid absent	A2				
Grid over frequency	A3		★	◎	○
Grid under frequency	A4				
Grid unbalance	A6				
PV over voltage	B0				
PV under voltage	B4	★	◎	◎	○
Weak radiation	B5				
Strings abnormal	B3				
Inverter over temperature	C5	◎	◎	◎	★
Fan abnormal	C8				
Insulation resistance abnormal	B1	●	○	○	●
Leakage current abnormal	B2	○	●	○	●
Strings reverse	B7	○	○	●	●
Control power abnormal	C0	○	★	○	●
DC bias current abnormal	C2	★	●	★	●
Inverter relay abnormal	C3	○	●	●	●
Leakage current HCT abnormal	C6	●	●	○	●
System fault	C7	★	★	★	●
DC link voltage unbalance	C9	●	○	●	●
DC link over voltage	CA	○	●	★	●
Internal Communications Fault	CB	○	○	★	●
Software version incompatibility	CC	★	●	○	●
EEPROM fault	CD	★	○	●	●
Sampling inconsistency	CE	★	●	●	●
Invert circuit abnormal	CF	●	●	●	●
Boost circuit abnormal	CG	★	○	○	●

Note: ● light on ○ light off ★ light blink ◎ keep original status

Maintenance

Check periodically that the heat sink is free from dust and blockage. If necessary, clean periodically the heat sink to ensure its good heat dissipation.

The Inverter Troubleshooting

If any abnormal phenomena occur, refer to below table for trouble shooting. If failed, call your dealer for help.

Issue	Solution
No display	1. Check DC switch of inverter is on or off 2. If there is PV combiner box, check fuse, terminal, wires
No generation	1. Check AC breaker is on or off 2. Wait stronger sunshine 3. Check the number of PV panel 4. To operate according to inverter's manual
Inverter abnormal	1. Disconnect both AC and DC breakers 2. Wait as less 10 minutes and switch on AC and DC breaker 3. Check whether inverter run normally or not
Power generation is less than expected	1. Ensure that inverter is free from direct sun exposure and good ventilation 2. Check that inverter isn't dust clogging, fans run normally 3. Ensure enough installation distance between inverters